









# More Precision

**optoNCDT** // Laser displacement sensors (triangulation)





-  **Ideal for serial and OEM applications**
-  **Compact design with integrated controller**
-  **Measuring rate up to 4kHz**
-  **Analog (U/I) and digital output**
-  **Trigger input / teach-in zero-setting / mastering**
-  **Configuration via web interface or Plug & Play**
-  **Application-specific presets and individual setups**
- ATC** **Auto Target Compensation**

The optoNCDT 1420 offers a unique combination of speed, size, performance and application versatility in the range of compact triangulation sensors. The sensor with integrated controller is used in restricted installation space or dynamic applications. The selectable connector type, i.e. cable or pigtail, together with compact size reduce the sensor installation effort to a minimum. The Auto Target Compensation (ATC) provides stable distance signal control. The high-performance optical system projects the small light spot sharply onto the measurement object which enables to even detect smallest components and every little detail reliably.

**Highest precision in a minimum of space**

Compact size combined with low weight opens up new fields of application. Analog and digital output signals enable to integrate the sensor into plant or machine control systems. The triangulation sensor achieves a high measurement accuracy with measuring rates of up to 4kHz.

**Unique ease of use, individual results**

All optoNCDT 1420 models are operated using an extended web interface. The settings for the measurement task can be quickly selected using predefined presets.

The quality slider enables the sensor to be adapted to static and dynamic processes.

Up to eight user-specific sensors settings can be stored and exported in the setup management. The video signal display, the signal peak selection and a freely adjustable signal averaging enable to optimize the measurement task.

The ROI function (region of interest) allows e.g. for interfering signals in the background to be filtered out. The remaining signal peak is optimally corrected.

MR	SMR	Y
10	20	10
25	25	21
50	35	28
100	50	46
200	60	70
500	100	90

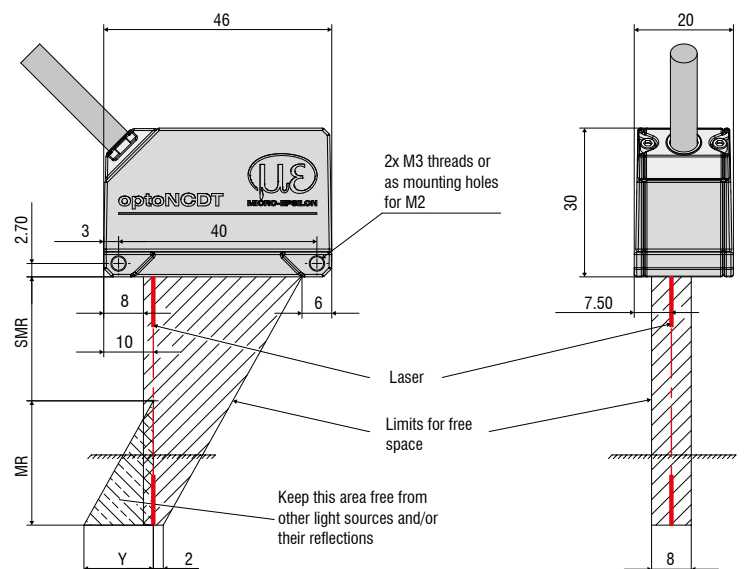

Model		ILD1420-10	ILD1420-25	ILD1420-50	ILD1420-100	ILD1420-200	ILD1420-500
Measuring range		10mm	25mm	50mm	100mm	200mm	500mm
Start of measuring range	SMR	20mm	25mm	35mm	50mm	60mm	100mm
Midrange	MMR	25mm	37.5mm	60mm	100mm	160mm	350mm
End of measuring range	EMR	30mm	50mm	85mm	150mm	260mm	600mm
Linearity <sup>1)</sup>		8 - 10 $\mu$ m	20 - 25 $\mu$ m	40 - 50 $\mu$ m	80 - 100 $\mu$ m	160 - 200 $\mu$ m	500 - 1000 $\mu$ m
		$\leq \pm 0.08 \dots 0.1\%$ FSO					$\leq \pm 0.1 \dots \leq \pm 0.2\%$ FSO
Repeatability <sup>2)</sup>		0.5 $\mu$ m	1 $\mu$ m	2 $\mu$ m	4 $\mu$ m	8 $\mu$ m	20 - 40 $\mu$ m
Measuring rate <sup>3)</sup>		0.25kHz / 0.5kHz / 1kHz / 2kHz / 4kHz					
Light source		Semiconductor laser <1 mW, 670nm (red)					
Permissible ambient light		10,000 lx					
Spot diameter $\pm 10\%$	SMR	90 x 120 $\mu$ m	100 x 140 $\mu$ m	90 x 120 $\mu$ m			
	MMR	45 x 40 $\mu$ m	120 x 130 $\mu$ m	230 x 240 $\mu$ m	750 x 1100 $\mu$ m	750 x 1100 $\mu$ m	750 x 1100 $\mu$ m
	EMR	140 x 160 $\mu$ m	390 x 500 $\mu$ m	630 x 820 $\mu$ m			
	smallest diameter	45 x 40 $\mu$ m with 24mm	55 x 50 $\mu$ m with 31mm	70 x 65 $\mu$ m with 42mm	-	-	
Protection class		IP65					
Laser protection class		Class 2 according to DIN EN 60825-1 : 2008-05					
Temperature stability		$\pm 0.03\%$ FSO/ $^{\circ}$ C					
Operating temperature		0 $^{\circ}$ C ... +50 $^{\circ}$ C (non-condensing)					
Storage temperature		-20 $^{\circ}$ C ... +70 $^{\circ}$ C (non-condensing)					
Control inputs/outputs		1x HTL Laser on/off; 1x HTL Multifunction input Trigger in / zero setting / mastering / teach (1x error output npn, pnp, push pull)					
Measurement value output	analog	4...20 mA (1-5 V with cable PCF1420-3/U); 12 bit; freely scalable within the measuring range <sup>4)</sup>					
	digital	RS422 / 16bit					
Vibration		20g / 20 ... 500Hz (according to IEC 60068-2-6)					
Shock		15g / 6ms / 3 axes (according to IEC 60068-2-29)					
Weight	with 3m cable	approx. 145g					
	with pigtail	approx. 60g					
Displays		2 x 3 color LEDs for power and status					
Operation	button	Select button for zero / teach / factory settings					
	web interface	Application-specific presets; peak selection, video signal; freely selectable averaging possibilities; data reduction; setup management <sup>5)</sup>					
Power supply		11-30V DC, 24V P < 2W					
Sensor cable		3m integrated, open ends					
		0.3m pigtail with 12-pole M12 connector					
Electronics		integrated signal processor					
Electromagnetic compatibility (EMC)		EN 61 000-6-3 / DIN EN 61326-1 (Class B) EN 61 000-6-2 / DIN EN 61326-1					

FSO = Full Scale Output; The specified data apply to a white, diffuse reflecting surface (reference: ceramics)

SMR = start of measuring range; MMR = midrange; EMR = end of measuring range

<sup>1)</sup> Values apply from 0 - 50% FSO or 50 - 100% FSO; <sup>2)</sup> Measuring rate: 2kHz, median 9;

<sup>3)</sup> Factory setting 2kHz; modifying the factory settings requires the IF2001/USB converter (optionally available)

<sup>4)</sup> The d/a conversion is executed with 12 Bit; <sup>5)</sup> Connection to PC via IF2001/USB (optionally available)

**Accessories for all optoNCDT Series****Power supply**

- PS 2020 (power supply 24 V / 2.5 A, input 100 - 240 VAC, output 24 VDC / 2.5 A, mounting onto symmetrical standard rail 35mm x 7.5mm, DIN 50022)

**Controller unit for evaluation and signal conversion**

- CSP 2008 (controller for multiple signal processing; analog and digital interfaces)

**Controller unit for evaluation and signal conversion**

- C-Box/2A (controller for conversion and evaluation of up to two sensor signals)

**Interface card**

- IF2008 (interface card for multiple signal processing; analog and digital interfaces)

**USB converter**

- IF2001/USB RS422/USB Converter (converter for digital signals in USB)

**USB converter**

- IF2004/USB 4 channels RS422/USB Converter (converter, up to 4 digital signals in USB)

**Accessories optoNCDT 1320/1420/1402CL1****Supply and output cable, drag-chain suitable**

- PCF1420-1/I (1m, output 4...20mA)
- PCF1420-1/I(O1) (1m, output 4...20mA)
- PCF1420-3/I (3m, output 4...20mA)
- PCF1420-6/I (6m, output 4...20mA)
- PCF1420-10/I (10m, output 4...20 mA)
- PCF1420-15/I (15m, output 4...20mA)
- PCF1420-3/U (3m, with integrated resistor, output 1...5 VDC)\*
- PCF1420-6/U (6m, with integrated resistor, output 1...5 VDC)\*
- PCF1420-10/U (10m, with integrated resistor, output 1...5 VDC)\*
- PCF1420-15/U (15m, with integrated resistor, output 1...5 VDC)\*
- PCF1420-3/IF2008 (3m, interface and supply cable)
- PC1420-6/IF2008 (6m, supply and output cable)
- PCF1420-10/IF2008 (10m, interface and supply cable)
- PC 1402-3/CSP (3m, connection cable for CSP 2008, only for optoNCDT 1420)

\* on request with output 2...10 VDC

**Supply and output cable, suitable for use with robots**

(available in 90° version)

- PCR 1402-3/I (3m)
- PCR 1402-6/I (6m)
- PCR 1402-8/I (8m)

**Accessories optoNCDT 1610/1630****Supply and output cable**

- PC 1605-3 (3m)
- PC 1605-6 (6m)
- PC 1607-5/BNC (5m, BNC connector)

**Accessories optoNCDT1700/1700LL/1700BL****Supply and output cable (drag-chain suitable)**

- PC 1700-3 (3m)
- PC 1700-10 (10m)
- PC 1700-10/IF2008 (10m, for use with interface card IF2008)
- PC 1700-3/T (3m, for use with trigger box)
- PC 1700-10/T (10m, for use with trigger box)
- PC 1700-3/USB (3m, with USB-RS422-converter, power supply 90 ... 230 VAC)

**Supply and output cable (suitable for use with robots)**

- PCR 1700-5 (5m)
- PCR 1700-10 (10m)

**Supply and output cables for temperatures up to 200°C**

- PC1700-3/OE/HT (3m)
- PC1700-6/OE/HT (6m)
- PC1700-15/OE/HT (15m)

**Protection housing**

- SGHF (with air-purge collar), sizes S and M
- SGH (without air-purge collar), sizes S and M
- SGHF-HT (with water cooling)

**Accessories optoNCDT 2300/2300LL/2300BL****Supply and output cable**

- PC2300-0,5Y (connection cable to PC or SPS; for operation a PC2300-3/SUB-D will be required)
- PC2300-3/SUB-D (3m; for operation a PC2300-0,5Y will be required)
- PC 2300-3/CSP (3m, connection cable ILD2300-UniController)
- PC 2300-3/IF2008 (interface and supply cable)
- PC 2300-3/OE (3m)
- PC 2300-6/OE (6m)
- PC 2300-9/OE (9m)
- PC 2300-3/CSP (3m, connection cable ILD2300-UniController)
- PC 2300-10/CSP (10m, connection cable ILD2300-UniController)
- PC 2300-15/CSP (15m, connection cable ILD2300-UniController)
- PC 2300-15/OE (15m)

\* other cable lengths on request

**Protection housing**

- SGHF (with air-purge collar), sizes S and M
- SGH (without air-purge collar), sizes S and M
- SGHF-HT (with water cooling)

**Supply and output cables for temperatures up to 200°C**

- PC2300-3/OE/HT (3m)
- PC2300-6/OE/HT (6m)
- PC2300-9/OE/HT (9m)
- PC2300-15/OE/HT (15m)

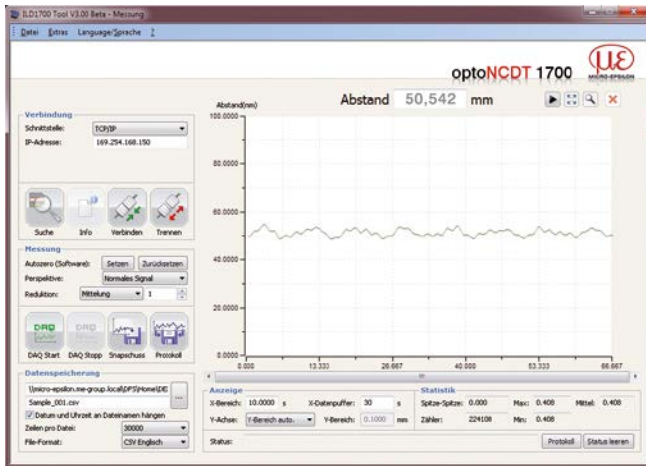

### Setup and configuration software

The scope of supply includes a software for easy sensor configuration. The settings can be implemented conveniently via a Windows user interface on the PC. The sensor parameters are sent to the sensor via the serial port and can also be saved if required. The software is available as single and multi-channel version. The sensor is connected to the PC via the sensor cable using a USB converter.  
[for any ILD sensor]

### Free download

Download free of charge from [www.micro-epsilon.com/download](http://www.micro-epsilon.com/download): software, driver and well-documented driver DLL for easy sensor integration in existing or customer software.

### Protection housing for harsh environment

To protect the laser sensors in extreme environments, individual protective housings are available for all sensor models. There are three different models:

#### SGH model:

Completely enclosed housing with an integrated front window, where the sensor measures through the window. The water-resistant housing provides protection against solvents and detergents.

#### SGHF model:

With window and compressed-air connection ideal for high ambient temperatures. The integrated air cooling of the housing offers optimum protection for the sensor.

#### SGHF-HT model:

This water-cooled protection housing with window and compressed-air connection is designed for measurement tasks in ambient temperatures up to 200°C.

Suitable for all long-range sensors

optoNCDT 1710

optoNCDT 1700-500 and optoNCDT 1700-750

optoNCDT 2310

optoNCDT 2300-200

Maximum ambient temperature 200°C

Maximum cooling water temperature  $T(\max) = 10^\circ\text{C}$

Minimum water flow rate  $Q(\min) = 3$  liters/min



**SGx ILD size S (140x140x71mm)**  
for optoNCDT 1700 / 2300 dimensions 97x75mm

**SGx ILD size M (140x180x71mm)**  
for optoNCDT 1700 / 2300 dimensions 150x80mm



### IF2008 - PCI interface card

The IF2008 interface card is designed for installation in PCs and enables the synchronous capture of four digital sensor signals and two encoders. The IF2008E expansion board enables the acquisition of two digital sensor signals, two analog sensor signals and eight I/O signals. The absolutely synchronous data acquisition plays an important role particularly for planarity or thickness measurement tasks. The data are stored in a FIFO memory in order to enable resource-saving processing in the PC in blocks.

#### Features

- 4x digital signals and 2x encoders with IF2008 basic PCB
- 2x digital signals, 2x analog signals and 8x I/O signals with IF2008E expansion board
- Additional expansion board for a total of 6x digital signals, 2x encoders, 2x analog signals and 8x I/O signals
- FIFO data memory
- Synchronous data acquisition

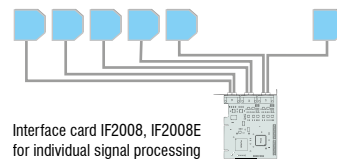

### IF2001/USB converter RS422 to USB

The RS422/USB converter transforms digital signals from a laser-optical sensor into a USB data packet. The sensor and the converter are connected via the RS422 interface of the converter. Data output is done via USB interface. The converter loops through further signals and features such as laser on/off, switch signals and function output. The connected sensors and the converter can be programmed through software.



### IF2004/USB: 4-channel converter from RS422 to USB

The RS422/USB converter is used for transforming digital signals from up to four optical sensors into USB data signals. The converter has four trigger inputs and a trigger output for connecting additional converters. Data is output via an USB interface. The connected sensors and the converter can be programmed through software.

#### Features

- 4x digital signals via RS422
- 4x trigger inputs, 1x trigger output
- Synchronous data acquisition
- Data output via USB



### C-Box controller for conversion and evaluation of up to two sensor signals

C-Box/2A is used for fast D/A conversion of two digital input signals or for evaluating two digital sensor signals. The controller is compatible with the optoNCDT 2300 laser triangulation sensors. Output of the sensor signals is possible via two configurable analog outputs, Ethernet or USB. Handling of the C-Box/2A and of the connected sensors are performed via web interface. Averaging functions, thickness, diameter, step and inclinations can be calculated. The D/A conversion is executed at 16 Bit and max. 70kHz.





### CSP2008 - Universal controller for up to six sensor signals

The controller CSP2008 has been designed to process two to six both optical and other sensors from Micro-Epsilon (6x digital or 4x analog input signals max., 2x internal + 4x external via Beckhoff EtherCAT modules). EtherCAT is intended as external bus for connecting further sensors and I/O modules. The controller is equipped with a display offering multi-color backlighting which changes its color in the case of exceeding the limit value while a signal is displayed.

### Features

- Real-time capability up to 100kHz (processing and output of measured values with 100kHz)
- Unique user interface (web browser) for the configuration of the controller via Ethernet on a PC. The user interface does not require any program installation. Display and storage of measured values on the PC via web browser.
- Simple sensor connection with automatic sensor recognition, configuration of the sensor using buttons and display on universal controller or via web browser
- Modular system upgradable with additional I/O modules for customer-specific requirements. Internal communication between I/O components via EtherCAT connection (CSP 2008 acts as master).
- Extremely flexible; function modules are freely combinable
- Simple mounting using mounting rail TS 35

### System design

#### Sensors via RS422

optoNCDT 1420  
optoNCDT 1700  
optoNCDT 2300  
optoCONTROL 2500  
optoCONTROL 2600  
confocalDT 2451/2471

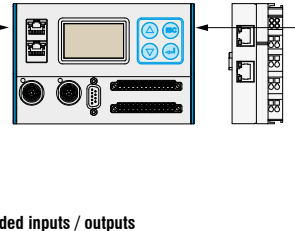

#### Beckhoff modules for extended inputs / outputs

EK1100, EtherCat bus coupler  
EL4102, analog output terminal, 0 ... +10V, 2 channels (16bit), EtherCAT  
EL4132, analog output terminal, -10... +10V, 2 channels (16bit), EtherCAT  
EL4024, analog output terminal, 4 ... 20mA, 4 channels (12bit), EtherCAT  
EL2002, digital output terminal, 24 VDC/ 0,5 A, 2 channels, EtherCAT  
EL2004, digital output terminal, 24 VDC/ 0,5 A, 4 channels, EtherCAT  
EL3142, analog input terminal, 0 ... 20mA, 2 channels (16bit), EtherCAT  
EL3162, analog input terminal, 0 ... 10V, 2 channels (16bit), EtherCAT  
EL1002, digital input terminal, 24 VDC/3 ms, 2 channels, EtherCAT  
EL1012, digital input terminal, 24 VDC/10  $\mu$ s, 2 channels, EtherCAT  
EL1014, digital input terminal, 24 VDC/10  $\mu$ s, 4 channels, EtherCAT  
EL1104, digital input terminal, 24 VDC/3 ms, 4 channels, EtherCAT  
EL5101, incremental encoder interface, RS485 differential inputs, EtherCAT  
EK1122, 2-Port EtherCAT junction  
RS422 extension terminal

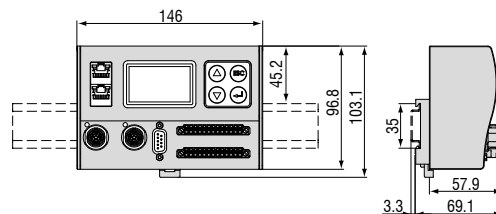

Universal controller with mounting rail TS 35  
(dimensions in mm, not to scale)

## High performance sensors made by Micro-Epsilon



Sensors and systems for displacement and position



Sensors and measurement devices for non-contact temperature measurement



2D/3D profile sensors (laser scanner)



Optical micrometers, fiber optic sensors and fiber optics



Color recognition sensors, LED analyzers and color online spectrometer



Measurement and inspection systems