

Submersible Liquid Level Sensors



AST4500

AST4510



For UL certified barrier drawing, see A01657.
For CSA certified barrier drawing, see A08949.

The AST4500 and AST4510 submersible liquid level sensors are approved to **UL/cUL913 (CSA 157) Class I Div 1, Groups C and D for use in intrinsically safe areas with an approved barrier.** It is also certified for ATEX / IECEx Class I Zone 0 Exia IIB T4 Ga (Ta = -40°C to +80°C). For pressure ranges from 0-1 to 0-100 PSI that require a wide range of media compatibility, the submersible series is an excellent solution to level monitoring for indoor and outdoor applications.

The AST4500 and AST4510 level sensors are completely sealed for submersion, yet vented through the cable to correct for barometric pressure changes. The welded housing is tested in-house via a helium leak tester to ensure proper protection. The conductors of the cable are also isolated from the outside environment to keep the sensor operational for long-term use.

With a removable nose cone, the AST4500 and AST4510 series can be also be installed outside of the tank through a 1/4" NPT pipe connection. In this configuration, the sensor continuously monitors the tank level through a threaded connection outside the tank, yet remains fully submersible for applications with flood prone environments or severe wash-down conditions. Available with voltage or 4-20mA output signals, AST can provide a cost effective solution for level monitoring for a variety of applications.

Benefits

- High Strength Stainless Steel Construction
- No Internal O-rings
- Wide Operating Temperature
- Pressures up to 100 PSI
- Low Static and Thermal Errors
- Unparalleled Price and Performance
- New Conduit Fitting at Electrical Connection
- Survives Harsh Environments
- Compatible with Wide Variety of Liquids
- EMI/RFI Protection
- ABS (American Bureau of Shipping) Approved

Applications

- Ground Water Level
- Bio-Fuels
- Salt Water Holding Tanks
- Gasoline & Diesel Fuel Tanks
- Fertilizer Tanks
- Earthen & Concrete Dams
- Irrigation Equipment
- Ballast Tanks
- Oil Tanks
- Waste Water Canals

Environmental Data

Temperature

Operating -40 to 80°C (-40 to 176°F)

Storage -40 to 100°C (-40 to 212°F)

Thermal Limits

Compensated Range 0 to 55°C (32 to 131°F)

TC Zero <±1.5% of FS (<±2.5%, typ. for 1PSI)

TC Span <±1.5% of FS (<±2.5%, typ. for 1PSI)

Other

Shock 100G, 11 msec, 1/2 sine

Vibration 10G peak, 20 to 2000 Hz.

EMI/RFI Protection: Yes

Rating: IP-68

Performance @ 25°C (77°F)

Accuracy* < ±0.25% BFSL (<±0.5% BFSL for 0-1 PSI)

Stability (1 year) ±0.25% FS, typical

Over Range Protection 2X Rated Pressure

Burst Pressure 5X or 1,250 PSI (whichever is less)

Pressure Cycles > 50 Million

Electrical Data

	Output	4-20mA	1-5VDC
Excitation		10-28VDC	10-28VDC
Output Impedance		>10k Ohms	<100 Ohms, Nominal
Current Consumption:		20mA, typical	<10mA
Bandwidth		(-3dB): DC to 250 Hz	(-3dB): DC to 1kHz
Output Noise:		-	<2mV RMS
Zero Offset:		<±1% of FS (<±4% 1PSI)	<±1% of FS (<±4% 1PSI)
Span Tolerance:		<±2% of FS (<±4% 1PSI)	<±1.5% of FS (<±4% 1PSI)
Output Load:		0-800 Ohms@10-28VDC	10k Ohms, min
Reverse Polarity Protection		Yes	Yes



Ordering Information

AST4510	L	00005	P	4	N	1	000	-SS
Series Type								
Process Connection L= Cone								
Pressure Measurement Insert 5-digit pressure code								
Pressure Unit B= Bar H= Inches H ₂ O		K= kg/cm ² P= PSI						
Outputs 3= 1-5V 4= 4-20mA (2 wire loop powered)								
Electrical N= Conduit fitting, Cable 6 ft. P= Conduit fitting, Cable 10 ft. X= Optional Length (see options)								
Wetted Material 1= 316L / 304 / Hytrel Cable / Kynar Cord Grip								
Options Cable Lengths:								
140= 15 ft. (4.6 m)	004= 35 ft. (10.7 m)	003= 100 ft. (30.5 m)						
075= 20 ft. (6.1 m)	130= 40 ft. (12.2 m)	050= 150 ft. (45.7 m)						
074= 25 ft. (7.6 m)	065= 50 ft. (15.2 m)							
Approval (Left Blank)= UL ANSI/ISA 12.12.01 Class I Div 1 Intrinsically Safe Groups C, D (formerly UL913) -SS= CSA157 Class I Div 1 Grps C, D Intrinsically Safe, ANSI/ISA 12.27.01 Single Seal and ATEX/IECEx Exia IIC Class I, Zone 0, T4								

Note: CSA approved products require case/earth ground electrical connection.
See wiring installation sheet for further details

Pressure Ranges*

	PSIG	Pressure Code	Feet of Water Column @ 4°C (approx.)
AST4500	0-100	00100	230.67
	0-50	00050	115.33
	0-30	00030	69.20
	0-20	00020	46.13
AST4510	0-15	00015	34.60
	0-10	00010	23.07
	0-7.5*	00208*	17.30
	0-5	00005	11.53
	0-2.5*	00069*	5.77
	0-1	00001	2.31

*All pressures between 0-1 PSI and 0-100 PSI are available. Please consult factory. *2.5 and 7.5 PSI Sensor must be ordered in inches of H₂O.

Submersible Liquid Level Sensors



AST4500

AST4510

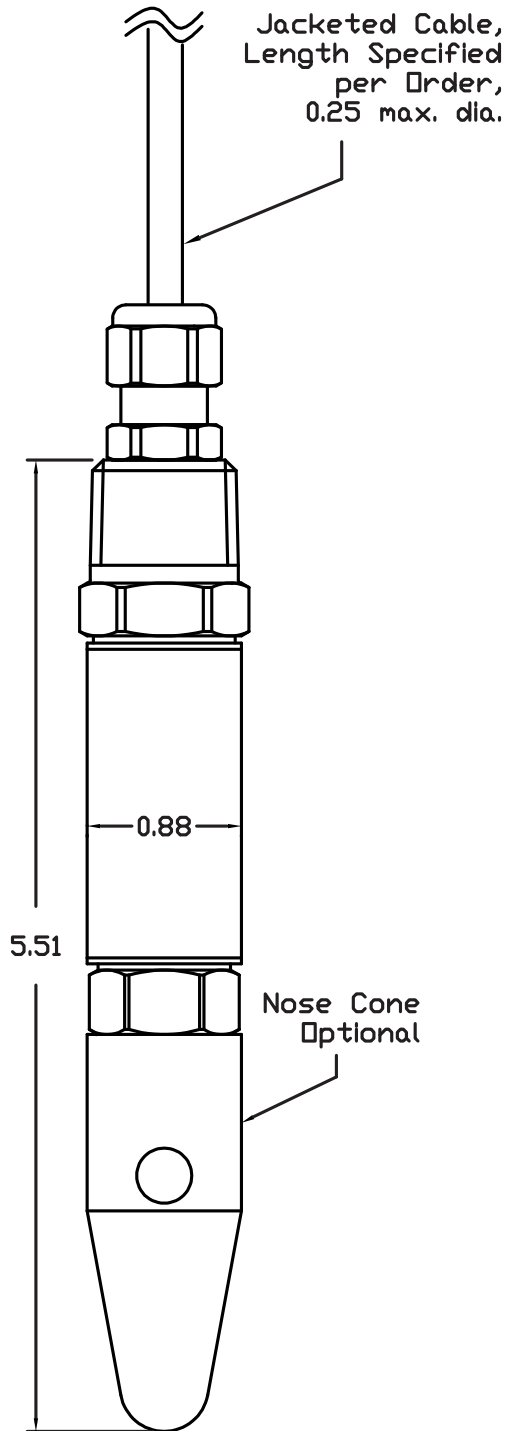

Submersible Liquid Level Sensors



AST4500

AST4510

UL Approved Barrier Installation / A01657

CSA Approved Barrier Installation / A08949

Class I, Div. 1, Groups C,D
Class I, Zone 0 Ex Ia IIB T4
Class I, Zone 0 AEx Ia IIB T4
OR
Class I, Div. 1, Groups A,B,C,D
Class I, Zone 0 Ex Ia IIC T4
Class I, Zone 0 AEx Ia IIC T4
Hazardous Location

Nonhazardous Location

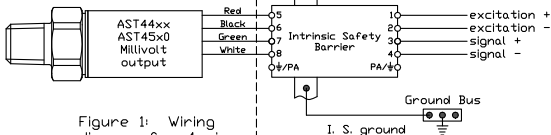

Figure 1: Wiring diagram for 4-wire, mV output

Class I, Div. 1, Groups C,D
EXia IIB, T4
Class I, Zone 0, AEXia IIB, T4
OR
Class I, Div. 1, Groups A,B,C,D
EXia IIC, T4
Class I, Zone 0, AEXia IIC, T4
Hazardous Location

Nonhazardous Location

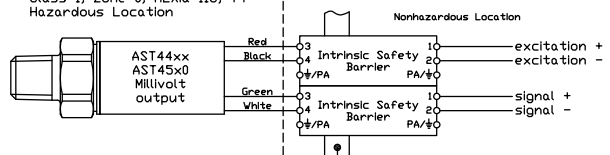

Figure 1: Wiring diagram for 4-wire, mV output

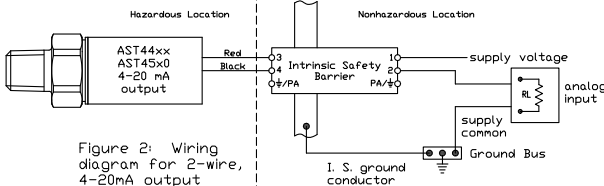

Figure 2: Wiring diagram for 2-wire, 4-20mA output

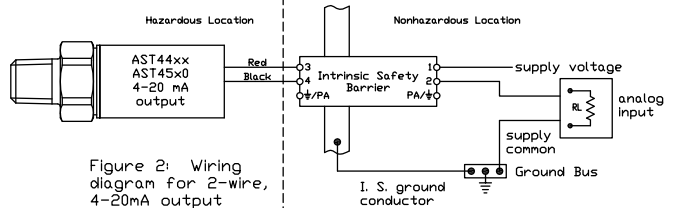

Figure 2: Wiring diagram for 2-wire, 4-20mA output

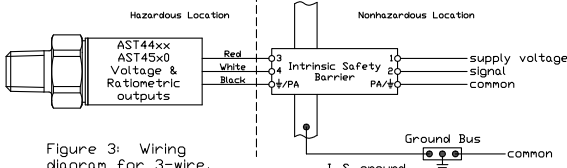

Figure 3: Wiring diagram for 3-wire, Voltage & Ratiometric outputs

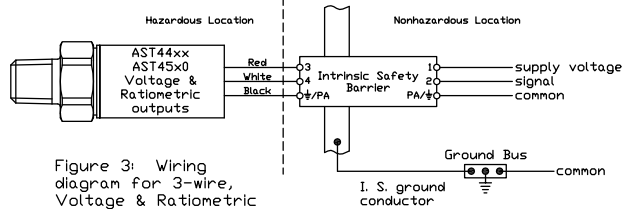

Figure 3: Wiring diagram for 3-wire, Voltage & Ratiometric outputs

The transducers listed below are designed for installation in EITHER Class I, Division 1, Groups C,D; Class I, Zone 0 Group IIB OR Class I, Division 1, Groups A,B,C,D; Class I, Zone 0 Group IIC hazardous locations when connected to Associated Apparatus as described in note 1.

Entity Parameters

Models AST4400, AST44LP, AST4500, AST4510, AST4520

Class I, Div. 1, Groups C,D; Class I, Zone 0 Ex Ia IIB T4; Class I, Zone 0 AEx Ia IIB T4
Vmax = 28V

Model AST4401

Class I, Div. 1, Groups A,B,C,D; Class I, Zone 0 Ex Ia IIC T4; Class I, Zone 0 AEx Ia IIC T4
Vmax = 14.5V

4-20mA with integral connector	4-20mA with upto 1000ft of integral cable	All EXCEPT 4-20mA with integral connector	All EXCEPT 4-20mA with upto 150ft of integral cable
Pmax = 651 mW Imax = 93 mA Ci = 0.391 uF Li = 0 uH	Pmax = 651 mW Imax = 93 mA Ci = 0.434 uF Li = 0 uH	Pmax = 651 mW Imax = 93 mA Ci = 0.643 uF Li = 0 uH	Pmax = 651 mW Imax = 93 mA Ci = 0.649 uF Li = 0 uH

Isc or Io is the total current available from the Associated Apparatus under any condition.

1. The following conditions must be satisfied:

- Voc or Uo <= Vmax
- Isc or Io <= Imax
- Po <= Pi (if applicable)
- Total customer cable length for 4-20mA transmitters not to exceed 4000ft.
- Total customer cable length for all other transmitters not to exceed 150ft.
- Where the cable capacitance and inductance per foot are not known, the following values shall be used: Ccable = 60pF/ft, Lcable = 0.2uH/ft

2. Control Room apparatus shall not generate in excess of 250V (Umax).

3. Canadian installations should be in accordance with Canadian Electrical Code, Part I. U.S. installations should be in accordance with Article 504 in the National Electrical Code, ANSI/NFPA 70.

Entity Parameters

Models AST4400, AST44LP, AST4500, AST4510, AST4520, AST4530
Class I, Div. 1, Groups C,D; EXia IIB, T4; Class I, Zone 0, AEXia IIB, T4
Vmax = 28Vdc

Model AST4401

Class I, Div. 1, Groups A,B,C,D; EXia IIC, T4; Class I, Zone 0, AEXia IIC, T4
Vmax = 14.5Vdc

4-20mA with integral connector	4-20mA with upto 1000ft of integral cable	All EXCEPT 4-20mA with integral connector	All EXCEPT 4-20mA with upto 150ft of integral cable
Pmax = 625 mW Imax = 93 mA Ci = 0.391 uF Li = 0	Pmax = 625 mW Imax = 93 mA Ci = 0.434 uF Li = 155 uH	Pmax = 625 mW Imax = 93 mA Ci = 0.643 uF Li = 0	Pmax = 625 mW Imax = 93 mA Ci = 0.649 uF Li = 23.3 uH

1. For installation in accordance with Fig 2, barrier must be a CSA Certified, Single Channel grounded Shunt-Diode Zener Barrier or a Single Channel Isolating Barrier.

2. For installations in accordance with Figs. 1 and 3, one dual-channel or two single-channel barriers may be used, where in either case, both channels have been Certified for use together with combined entity parameters.

3. The following conditions must be satisfied:

- Voc or Uo <= Vmax
- Isc or Io <= Imax
- Po <= Pi (if applicable)
- Ca or Co >= Ci + Ccable
- La or Lo >= Li + Lcable

4. Maximum non-hazardous area voltage must not exceed 250 V.

5. Canadian installations should be in accordance with Canadian Electrical Code, Part I. U.S. installations should be in accordance with Article 504 in the National Electrical Code, ANSI/NFPA 70.

6. A grounding method is not provided by the manufacturer as part of the integral design of the Transducer. For units which are connected through a grounded shunt diode safety barrier, ensure that the transducer is mounted to a surface which is at the same potential as the barrier ground.

7. See user manual for installation conditions.