

# PVDF/PTFE Submersible Pressure Transducer



AST4530



For CSA certified barrier drawing, see A08949.

The AST4530 submersible pressure transducer is constructed using PVDF material and a PTFE diaphragm. Designed to measure liquid level of corrosive liquids, the AST4530 features submersible PVDF cable, cord grip and housing. The AST4530 features a conduit connection for turbulent installations such as on-board ships, turbulent tanks, and rail cars.

Voltage and 4-20mA output signals allow users to interface for low current consumption or long distance transmission applications.

The AST4530 is CSA157 certified to Class I Div 1, Groups C and D for use in intrinsically safe areas with an approved barrier, ANSI/ISA 12.27.01 Single Seal Approved and ATEX / IECEx Exia IIB Class I, Zone 0, T4.

CAN/CSA C22.2 No 60079-0:11, ANSI/ISA 60079-0:09, CAN/CSA E60079-11:02, ANSI/ISA 60079-11:11, CAN/CSA C22.2N.157-92, UL 913 (6th Edition)

## Benefits

- ABS (American Bureau of Shipping) Approved
- Class I Zone 0 Exia IIB T4 Ga (Ta = 0°C to +60°C)
- Excellent liquid and gas compatibility
- Cost effective alternative to ultrasonic & radar sensor technologies
- Works with reflective liquids
- Will not fail due to vapor
- No galvanic corrosion or risk of bacteria

## Applications

- Chemical totes
- Salt water holding tanks
- Process plants
- Rail-car liquid level monitoring
- Storage tanks

## Environmental Data

### Temperature

Operating	0 to 60°C (32 to 140°F)
Storage	0 to 80°C (32 to 176°F)

### Thermal Limits

Compensated Range	0 to 55°C (32 to 131°F)
TC Zero: <math>\pm 2.0\%</math> of FS	TC Span: <math>\pm 2.0\%</math> of FS

### Other

Shock	100G, 11 msec, 1/2 sine
Vibration	10G peak, 20 to 2000 Hz.
EMI/RFI Protection:	Yes
Rating:	IP-68
Fill Fluids	Glycol / Silicone Oil

## Performance @ 25°C (77°F)

Accuracy*	<math>\pm 0.5\%</math> BFS
Over Range Protection	2X Rated Pressure
Burst Pressure	5X or 1,250 PSI (whichever is less)
Pressure Cycles	> 50 Million

\*Accuracy includes non-linearity, hysteresis & non-repeatability

## Electrical Data

Output	4-20mA	1-5VDC	0.5-4.5V Ratiometric
Excitation	10-28VDC	10-28VDC	5VDC, regulated
Output Impedance	>10k Ohms	<100 Ohms, Nominal	<100 Ohms, Nominal
Current Consumption:	20mA, typical	3mA, typical	3mA, typical
Bandwidth	(-3dB): DC to 250 Hz	(-3dB): DC to 1kHz	(-3dB): DC to 1kHz
Output Noise:	-	<2mV RMS	<2mV RMS
Zero Offset:	<math>\pm 1\%</math> of FS	<math>\pm 1\%</math> of FS	<math>\pm 1\%</math> of FS
Span Tolerance:	<math>\pm 1\%</math> of FS	<math>\pm 1\%</math> of FS	<math>\pm 1\%</math> of FS
Output Load:	0-800 Ohms@10-28VDC	10k Ohms, min	10k Ohms, min
Reverse Polarity Protection	Yes	Yes	Yes



## Ordering Information

**AST4530**   **I**   **00020**   **P**   **4**   **X**   **9**   **354**

**Series Type**

**Process Connection**

I= 1/4" FNPT  
(Not intended for threaded installation.)

**Pressure Range**

Insert 5-digit pressure code

**Pressure Unit**

B= Bar    K= kg/cm<sup>2</sup>  
H= Inches H<sub>2</sub>O                                  P= PSI

**Outputs**

1= 0.5-4.5V ratiometric    3= 1-5V    4= 4-20mA

**Electrical** (for wiring information visit: <http://www.astensors.com/wiring.php>)

X= See Options Below

**Wetted Material**

9= PVDF / PTFE / Viton

**Options** Cable Lengths:

353 = 25 ft. (7.62 m)      354 = 50 ft. (15.24 m)      355 = 75 ft. (22.86 m)

## Pressure Ranges

<b>PRESSURE PSIG</b>	0-30	<b>PRESSURE CODE</b>	00030	P
	0-20		00020	P
	0-15		00015	P
	0-10		00010	P
	0-7.5*		00208*	H
	0-5		00005	P
	0-2.5*		00069*	H

<b>Feet of Water Column @ 4°C (approx.)</b>	6	<b>PRESSURE CODE</b>	00072	H
	10		00120	H
	20		00240	H
	30		00360	H
	50		00600	H

\*Requires "H" pressure unit for inches H<sub>2</sub>O  
Notes: Other pressures available. Contact Factory

# PVDF/PTFE Submersible Pressure Transducer



AST4530

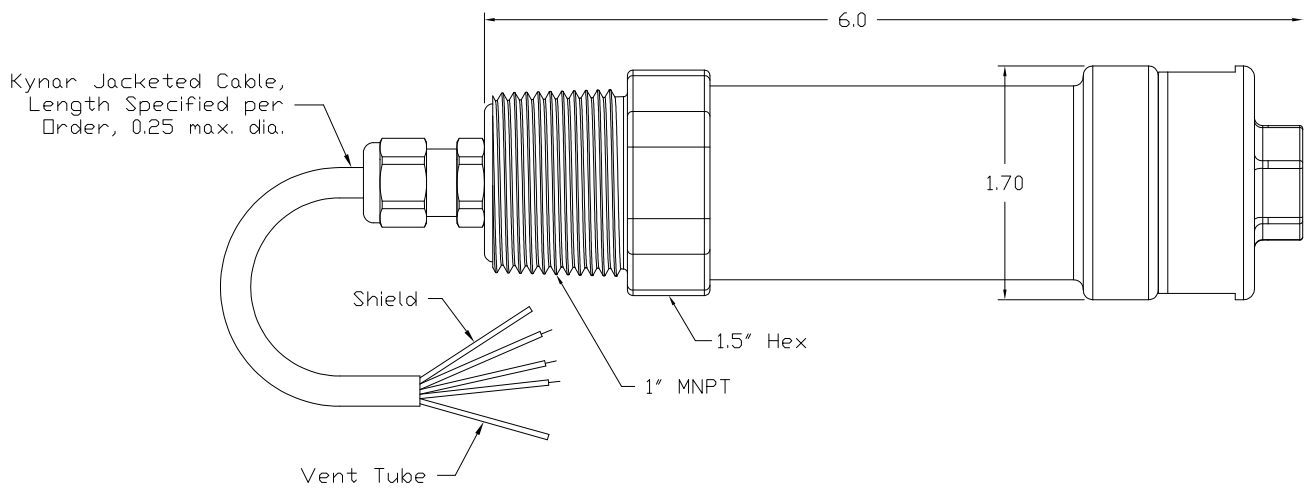

# PVDF/PTFE Submersible Pressure Transducer



AST4530

## CSA Approved Barrier Installation / A08949

Class I, Div. 1, Groups C,D  
Class I, Zone 0 Ex Ia IIB T4  
Class I, Zone 0 AEx Ia IIB T4  
OR  
Class I, Div. 1, Groups A,B,C,D  
Class I, Zone 0 Ex Ia IIC T4  
Class I, Zone 0 AEx Ia IIC T4  
Hazardous Location

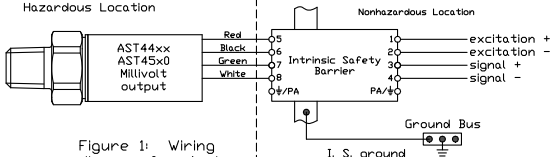

Figure 1: Wiring diagram for 4-wire, mV output

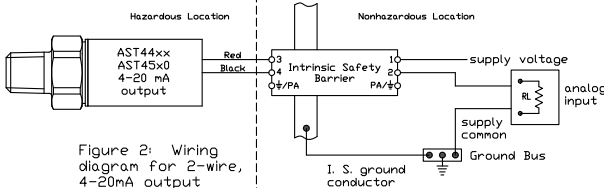

Figure 2: Wiring diagram for 2-wire, 4-20mA output

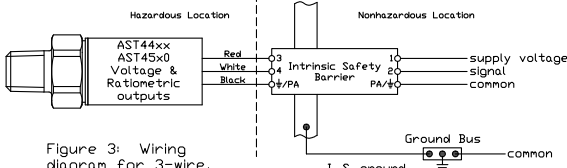

Figure 3: Wiring diagram for 3-wire, Voltage & Ratiometric outputs

The transducers listed below are designed for installation in EITHER Class I, Division 1, Groups C,D; Class I, Zone 0 Group IIB OR Class I, Division 1, Groups A,B,C,D; Class I, Zone 0 Group IIC hazardous locations when connected to Associated Apparatus as described in note 1.

### Entity Parameters

Models AST4400, AST44LP, AST4500, AST4510, AST4520

Class I, Div. 1, Groups C,D; Class I, Zone 0 Ex Ia IIB T4; Class I, Zone 0 AEx Ia IIB T4  
 $V_{max} = 28V$

### Model AST4401

Class I, Div. 1, Groups A,B,C,D; Class I, Zone 0 Ex Ia IIC T4; Class I, Zone 0 AEx Ia IIC T4  
 $V_{max} = 14.5V$

4-20mA with integral connector	4-20mA with upto 1000ft of integral cable	All EXCEPT 4-20mA with integral connector	All EXCEPT 4-20mA with upto 150ft of integral cable
$P_{max} = 651 mW$	$P_{max} = 651 mW$	$P_{max} = 651 mW$	$P_{max} = 651 mW$
$I_{max} = 93 mA$	$I_{max} = 93 mA$	$I_{max} = 93 mA$	$I_{max} = 93 mA$
$C_i = 0.391 \mu F$	$C_i = 0.434 \mu F$	$C_i = 0.643 \mu F$	$C_i = 0.649 \mu F$
$L_i = 0 \mu H$	$L_i = 0 \mu H$	$L_i = 0 \mu H$	$L_i = 0 \mu H$

IsC or Io is the total current available from the Associated Apparatus under any condition.

### 1. The following conditions must be satisfied:

- $V_{oc}$  or  $U_o \leq V_{max}$        $C_a$  or  $C_o \geq C_i + C_{cable}$   
 $I_{sc}$  or  $I_o \leq I_{max}$        $L_a$  or  $L_o \geq L_i + L_{cable}$   
 $P_o \leq P_i$  (if applicable)  
 Total customer cable length for 4-20mA transmitters not to exceed 4000ft.  
 Total customer cable length for all other transmitters not to exceed 150ft.  
 Where the cable capacitance and inductance per foot are not known,  
 the following values shall be used:  $C_{cable} = 60pF/ft$ ,  $L_{cable} = 0.2\mu H/ft$

### 2. Control Room apparatus shall not generate in excess of 250V ( $U_{max}$ ).

### 3. Canadian installations should be in accordance with Canadian Electrical Code, Part I. U.S. installations should be in accordance with Article 504 in the National Electrical Code, ANSI/NFPA 70.

Class I, Div. 1, Groups C,D  
EXia IIB, T4  
Class I, Zone 0, AExIa IIB, T4  
OR  
Class I, Div. 1, Groups A,B,C,D  
EXIa IIC, T4  
Class I, Zone 0, AExIa IIC, T4  
Hazardous Location

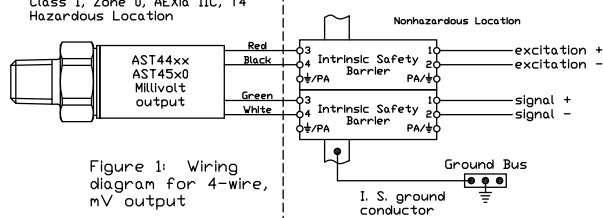

Figure 1: Wiring diagram for 4-wire, mV output

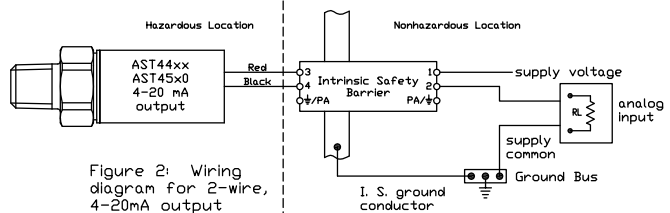

Figure 2: Wiring diagram for 2-wire, 4-20mA output

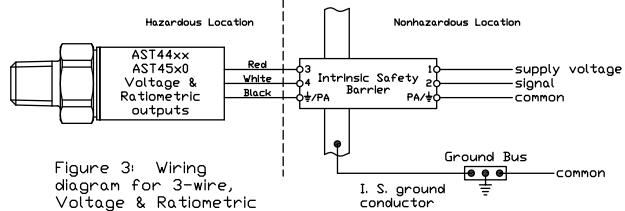

Figure 3: Wiring diagram for 3-wire, Voltage & Ratiometric outputs

### Entity Parameters

Models AST4400, AST44LP, AST4500, AST4510, AST4520, AST4530

Class I, Div. 1, Groups C,D; EXIa IIB, T4; Class I, Zone 0, AExIa IIB, T4  
 $V_{max} = 28Vdc$

### Model AST4401

Class I, Div. 1, Groups A,B,C,D; EXIa IIC, T4; Class I, Zone 0, AExIa IIC, T4  
 $V_{max} = 14.5Vdc$

4-20mA with integral connector	4-20mA with upto 1000ft of integral cable	All EXCEPT 4-20mA with integral connector	All EXCEPT 4-20mA with upto 150ft of integral cable
$P_{max} = 625 mW$	$P_{max} = 625 mW$	$P_{max} = 625 mW$	$P_{max} = 625 mW$
$I_{max} = 93 mA$	$I_{max} = 93 mA$	$I_{max} = 93 mA$	$I_{max} = 93 mA$
$C_i = 0.391 \mu F$	$C_i = 0.434 \mu F$	$C_i = 0.643 \mu F$	$C_i = 0.649 \mu F$
$L_i = 0 \mu H$	$L_i = 155 \mu H$	$L_i = 0 \mu H$	$L_i = 23.3 \mu H$

### 1. For installation in accordance with Fig 2, barrier must be a CSA Certified, Single Channel grounded Shunt-Diode Zener Barrier or a Single Channel Isolating Barrier.

### 2. For installations in accordance with Figs. 1 and 3, one dual-channel or two single-channel barriers may be used, where in either case, both channels have been Certified for use together with combined entity parameters.

### 3. The following conditions must be satisfied:

- $V_{oc}$  or  $U_o \leq V_{max}$        $C_a$  or  $C_o \geq C_i + C_{cable}$   
 $I_{sc}$  or  $I_o \leq I_{max}$        $L_a$  or  $L_o \geq L_i + L_{cable}$   
 $P_o \leq P_i$  (if applicable)

### 4. Maximum non-hazardous area voltage must not exceed 250 V.

### 5. Canadian installations should be in accordance with Canadian Electrical Code, Part I. U.S. installations should be in accordance with Article 504 in the National Electrical Code, ANSI/NFPA 70.

### 6. A grounding method is not provided by the manufacturer as part of the integral design of the Transducer. For units which are connected through a grounded shunt diode safety barrier, ensure that the transducer is mounted to a surface which is at the same potential as the barrier ground.

### 7. See user manual for installation conditions.